



# DH2100

## 2009-17 Ram 1500 Short, Standard & Long Box Installation Instructions

Serial Number

Please read these Installation Instructions in their entirety prior to installing or operating this equipment.

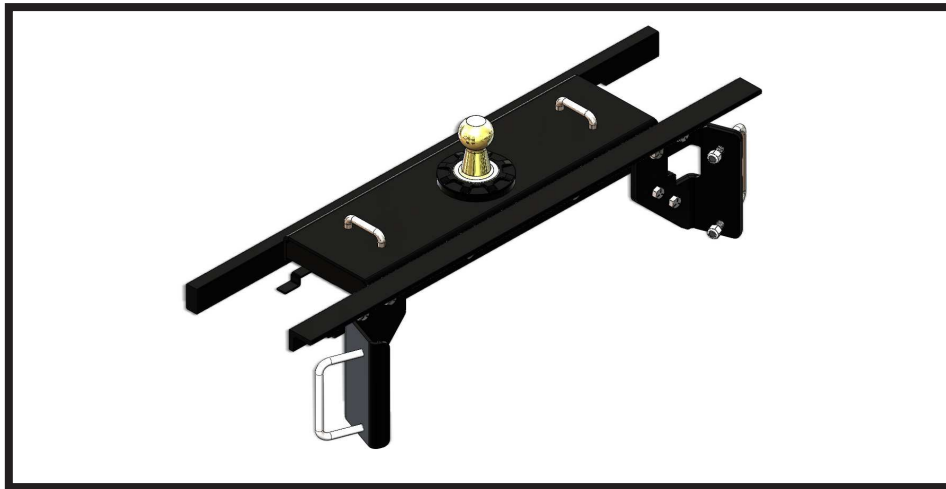

This hitch is rated to 30,000 lbs. Gross Towing Weight and 7,500 lbs. Tongue Weight

**Bolt Torque Specifications**  
Torque in Foot-Pounds for Inch Bolts

Bolt Size	Grade 5	Grade 8
1/4"	10	14
5/16"	19	29
3/8"	33	47
7/16"	54	78
1/2"	78	119
5/8"	154	230
3/4"	257	380

**Bolt Torque Specifications**  
Torque in Foot-Pounds for Metric Bolts

Bolt Size	Grade 8.8	Grade 10.9
6MM	6	8
8MM	16	22
10MM	31	40
12MM	54	70
14MM	89	117
16MM	161	230
18MM	222	318

**! WARNING**

Refer to your vehicle's owner's manual for maximum towing capacity. **DO NOT** exceed vehicle, tongue or hitch weight ratings - failure to follow vehicle manufacturer's recommendations could result in damage to your vehicle, personal injury or death.

**! WARNING**

Failure to read and follow these instructions could result in separation of the trailer from the truck, causing property damage, loss of towed vehicle, personal injury or death.

DH2100  
2009-17 Ram 1500 Short, Standard & Long Box  
Installation Instructions



- Trailer brakes are required.
- Do not use any open flame under the truck bed to cut or weld. There is extreme danger of explosion or fire.
- Vehicle must be securely blocked and brakes set before beginning to work underneath the vehicle.
- Do not clamp hitch over any wiring or brake lines.
- Always make sure trailer is loaded slightly tongue heavy. Do not pull a trailer that is lighter on the tongue end.
- Always insure the hitch ball is locked into the hitch prior to towing.

### ***Maintenance/Care***

- Periodically clean any dirt/debris from the ball and ball housing and moderately lubricate them with white lithium grease or equivalent grease.

**Instruction Notes:** The exhaust hangers are removed and reinstalled for the hitch installation. Some drilling and trimming is required.

Place all components that are removed on a flat, sturdy surface. All items will be reinstalled unless otherwise noted after the hitch is installed.

The dimensional variations between otherwise identical vehicles can be considerable. While this hitch was designed for easy installation, it may be necessary to modify the hitch slightly to compensate for vehicle manufacturer's tolerances.

### ***NOTICE***

- When a bed liner is installed, compensation of the bed liner thickness must be accounted for when measuring the ball location in the box bed.
- When using power drills be aware of the dangers of torque and drill bit length.
- When using a reciprocating saw be aware of objects behind the cutting surface.
- Use a good quality paint to spray cut edges of frame to prevent rusting.
- Be sure to use Loctite® Red on all bolts before tightening. Tighten all bolts according to the torque chart provided.
- The installer must instruct the operator on proper ball installation and locking procedures.
- Dealer or installer be certain the user receives these instruction sheets.
- If the hitch is in an accident, it must be replaced. **DO NOT** use it again! An accident can cause unseen damage and using it again could result in more damage or serious injury. **DO NOT** use the hitch if it is damaged or missing parts.
- When inverting the ball, ensure proper clearance between the ball and the truck's differential and drive line. Failure to do so may result in damage. A plug is included with all Blue Ox Gooseneck Hitches that can be used for covering the socket when the ball is removed.

# DH2100

## 2009-17 Ram 1500 Short, Standard & Long Box Installation Instructions

**Tools Required**

Torque Wrench  
 Drill  
 Tape Measure  
 Loctite® RED  
 5" Hole Saw  
 3/4" Socket  
 3/4" Wrench  
 1/2" Drill Bit  
 Center Punch

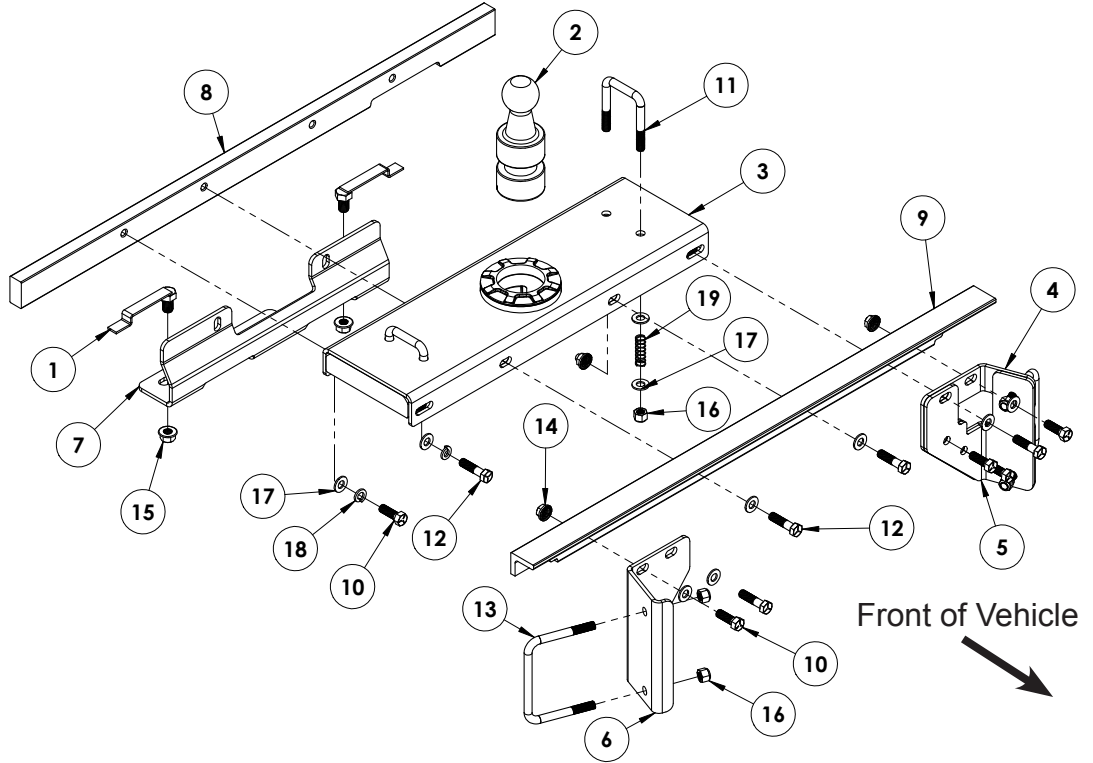

Item No.	Part No.	Description	Qty.
1.....	61-6828.....	5/8"-11 Hex Bolt Plate x 5"L.....	2
2.....	62-3822.....	Hitch Ball.....	1
3.....	62-3994.....	DH2100 Center Section.....	1
4.....	101-7623.....	DH2100 DS Plate.....	1
5.....	101-7624.....	DH2100 DS Support Plate.....	1
6.....	101-7625.....	DH2100 PS Plate.....	1
7.....	101-8326.....	DH2100 Back Support Plate.....	1
8.....	102-7483.....	DH2100 Back Cross Member.....	1
9.....	105-1576.....	DH2100 Front Cross Member.....	1
10.....	201-0051.....	1/2"-13 x 1-1/2" Hex Head Bolt, Grade 5, ZP.....	6
11.....	201-0275.....	1/2"-13 x 3-3/4" x 2-1/2" U-Bolt, ZP.....	2
12.....	201-0283.....	1/2"-13 x 2" Hex Head Bolt, Grade 5, ZP.....	6
13.....	201-0854.....	1/2"-13 x 5-1/2" x 4-1/4" U-Bolt, ZP.....	2
14.....	202-0072.....	1/2"-13 Hex Flange Whiz Lock Nut, ZP.....	8
15.....	202-0073.....	5/8"-11 Hex Flange Whiz Lock Nut, ZP.....	2
16.....	202-0094.....	1/2"-13 Hex Nylon Lock Nut, ZP.....	8
17.....	203-0005.....	1/2" Flat Washer, ZP.....	18
18.....	203-0012.....	1/2" Lock Washer, ZP.....	4
19.....	222-0091.....	Compression Spring (.049" Dia x .60" x 2").....	4
20.....	250-0264(not shown).....	Ball Housing Plug.....	1

**Important:**

Use only genuine factory replacement parts on your hitch. Do **NOT** substitute homemade or non-typical parts. If a bolt is lost or in need of replacement, for your safety and the preservation of your hitch, be sure to use a replacement bolt of the same grade (In most cases it will be Grade 5, please reference the parts list above). Replacement parts may be ordered through your nearest Blue Ox® Dealer or Distributor. Failing to follow and/or altering these installation instructions in either installation or required equipment will void the manufacturer's warranty.

DH2100  
2009-17 Ram 1500 Short, Standard & Long Box  
Installation Instructions



1. Use the jack handle to remove the spare tire as per the owner's manual.

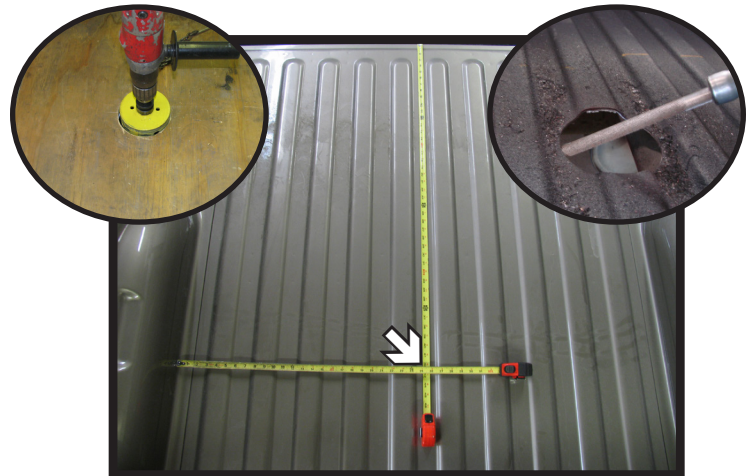

2. On the inside of the bed, measure from the rear (not the tailgate) forward 41-7/16" for a 8' bed or 39-7/16" for a 5'-7" / 6'-4" bed and mark. Measure between the wheel wells and mark center. Using a 5" holesaw, drill a hole thru the bed.

Note: Using a board while drilling decreases chances of the bit wobbling out of position (left inset). It is also recommended to debur the hole so the hitch will sit tight against the bed (right inset).

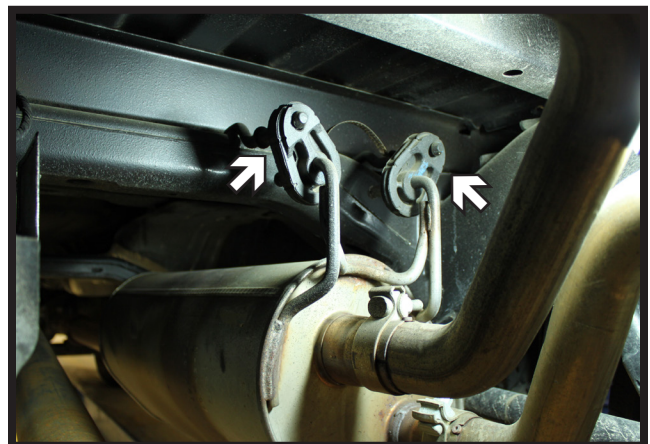
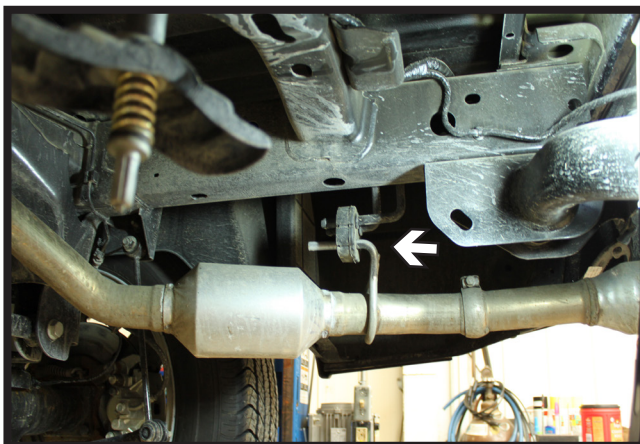

3. Drop the exhaust by sliding the hangers out of the rubber insulators.

Note: Using silicone spray on the hangers eases removal from rubber insulators.



DH2100  
2009-17 Ram 1500 Short, Standard & Long Box  
Installation Instructions

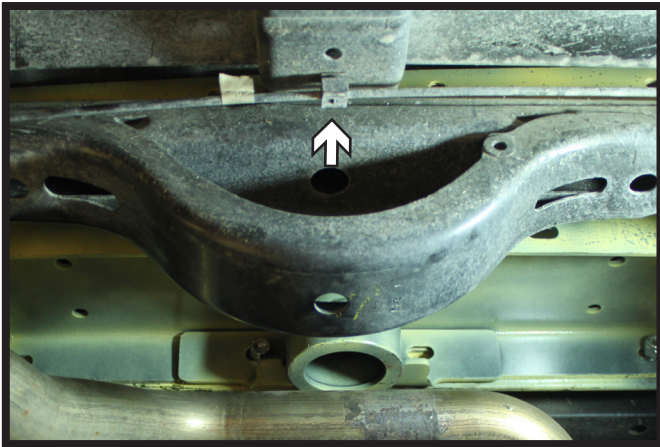

4. Unsnap the wiring from the backside of the cross member and move it towards the back of the truck for hitch installation.

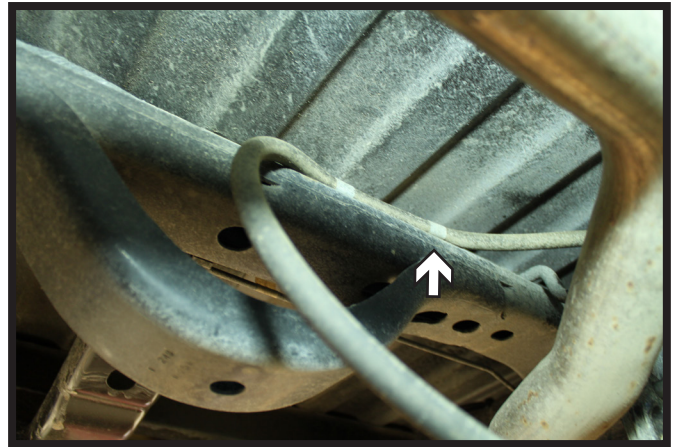

5. Unclip the vent tube and let it hang loosely. The vent tube will be relocated after the hitch is installed.

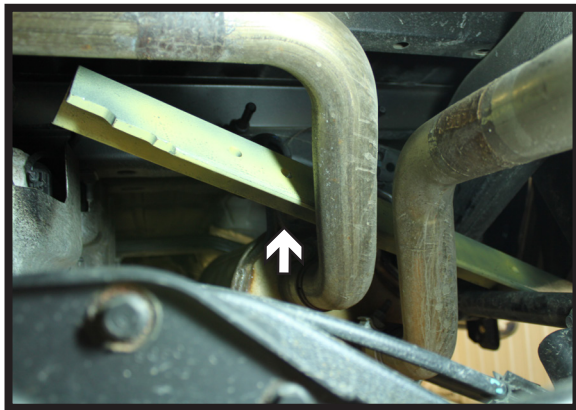

6. Slide the front angle up above the exhaust, between the frame and upper suspension. Rest it on the top of the frame until the cross member is installed. On the other side, slide the back support flat and rest it on the chassis frame. The notch on the back support flat should be facing toward the rear of the vehicle.

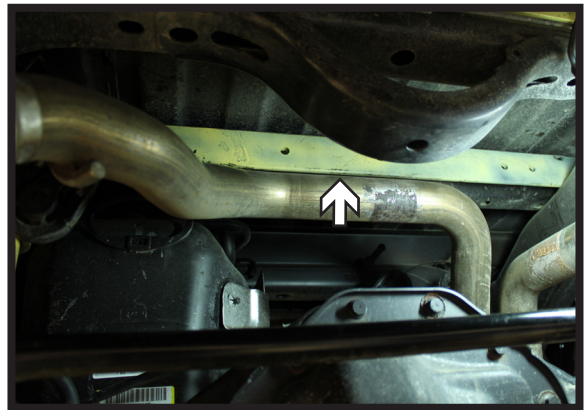

DH2100  
2009-17 Ram 1500 Short, Standard & Long Box  
Installation Instructions



7. Install the center section by gently pulling down on the muffler. Tip it at an angle in order to clear the frame. Align the slots with the holes in the front angle and back support flat. The hole for the hitch should also be aligned with the 5" hole in the truck bed. The offset of the ball housing in the center section should be towards the front.

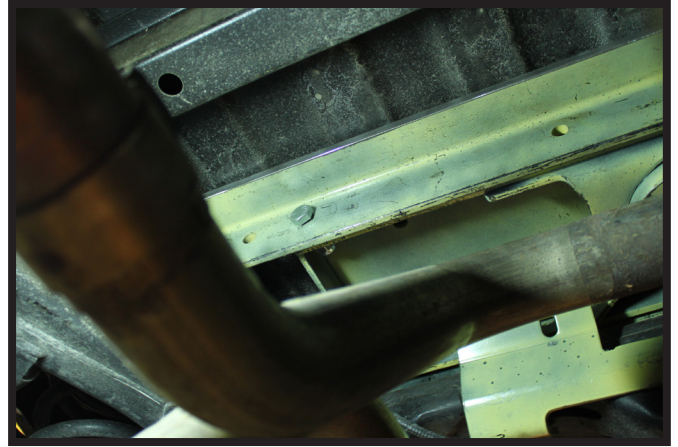

8. On the front angle insert the 1/2"-13 x 1-1/2" hex head bolts and nuts thru the center two (2) holes only. Insert the outer two (2) and center 1/2"-13 x 2" hex head bolts on the back support flat at this time also. Do not fully tighten at this time.

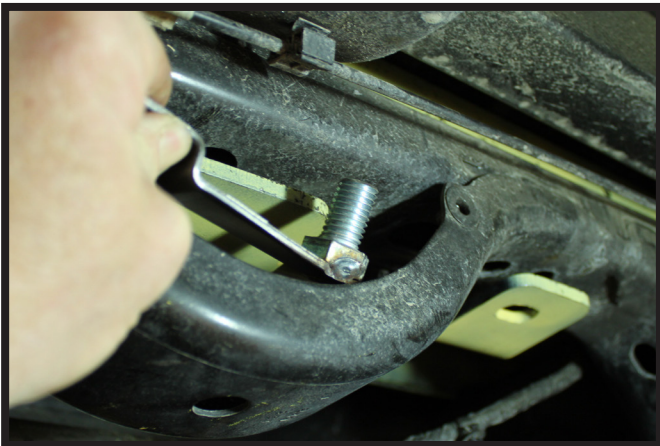

9. Attach the back support plate to the inside of the cross member. Insert the 1/2"-13 x 2" hex head bolts thru the back support plate and the threaded holes of the back support flat. Using the 5" bolt plates, reach through the frame and fasten the bottom of the back support plate. Tighten the bolts, the handle on the bolt plate will prevent the bolt from becoming loose.





DH2100  
2009-17 Ram 1500 Short, Standard & Long Box  
Installation Instructions

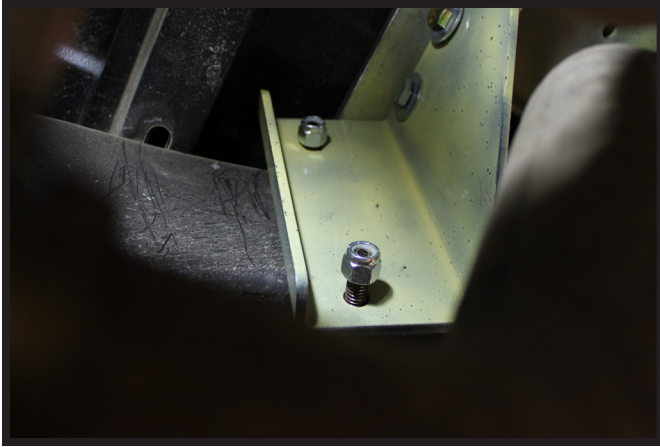

10. Place the support plate onto the frame side. Install the 5-1/2" x 4-1/4" u-bolt and finger tighten the nuts. Align top holes and install a 1/2"-13 x 1-1/2" bolt, 1/2" flat washer & lock nut. Do this on both sides of the vehicle. Do not tighten bolts at this time.



11. Reattach the wiring harness by using the cable ties that were provided.

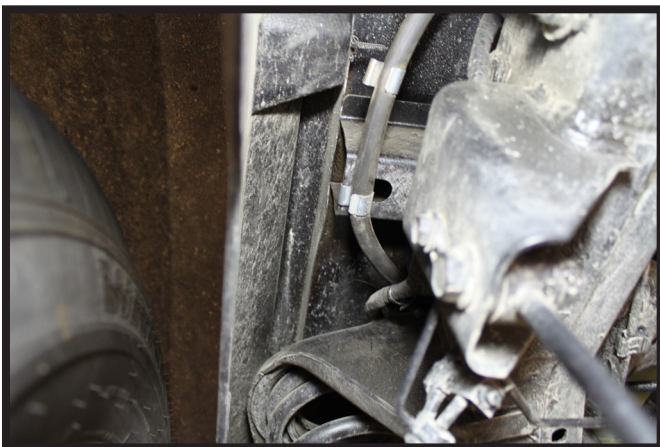

12. Looking towards the front of the vehicle, place the vent tube between the frame and brakes lines. Bring it up over the frame rail and clip it to the frame.

DH2100  
2009-17 Ram 1500 Short, Standard & Long Box  
Installation Instructions

13. Verify all parts are properly placed and tighten all bolts.

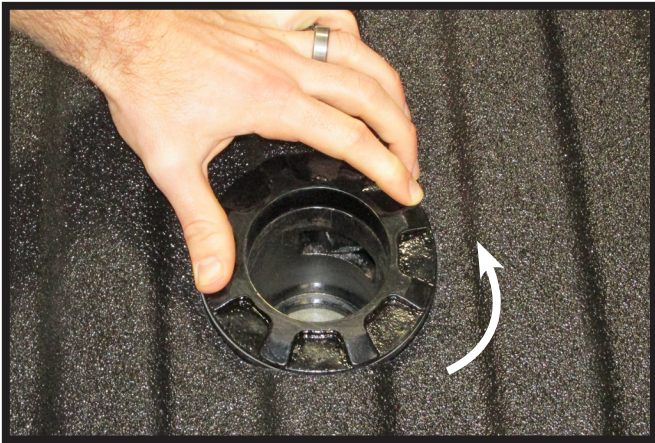

14. Check the rotation of the top collar at this time to insure the bed is not rubbing against it and it can rotate freely. If necessary drop the center section and remove any obstructions.

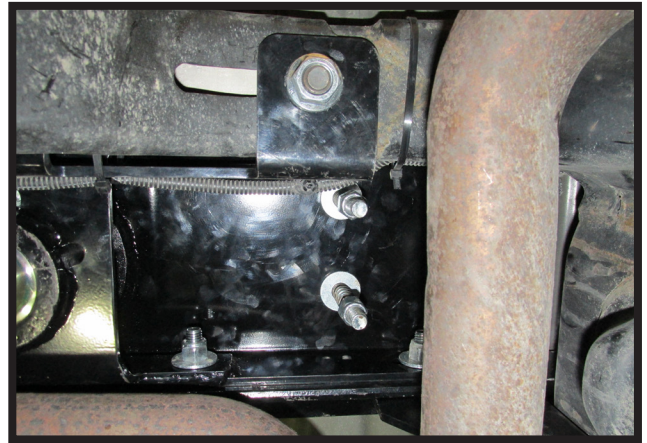

15. Using a 19/32" drill bit, drill the two (2) holes closest to the ball thru the bed. Do this on both sides of the center section. Insert the 1/2"-13 u-bolts thru the holes from the topside. Install a 1/2" flat washer, a spring, another 1/2" flat washer and 1/2"-13 lock nut onto each u-bolt stud. Tighten until the washers are touching the spring without compressing it.



DH2100  
2009-17 Ram 1500 Short, Standard & Long Box  
Installation Instructions

### Installing the Hitch Ball

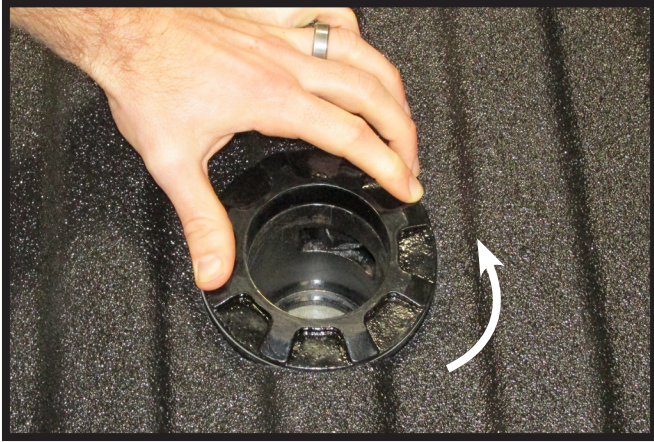

1. Rotate the locking collar to release the latch pawl.

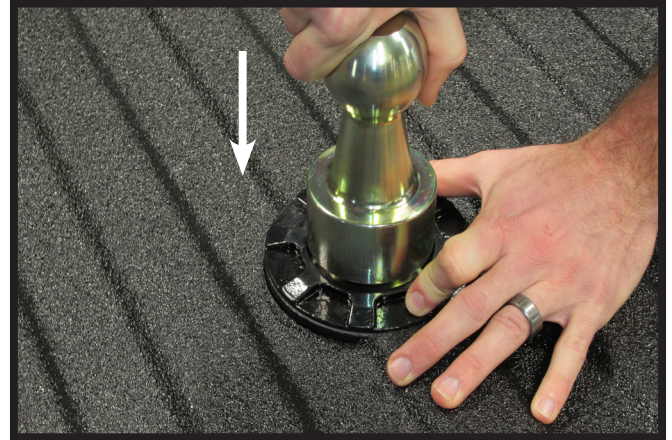

2. Align the ball with the collar and drop the ball into the hitch. Release the locking collar. Pull up on the ball to insure it is locked into the housing.

### Removing the Hitch Ball



1. Rotate the locking collar to release the latch pawl. Pull straight up on the ball to remove from the hitch.

DH2100  
2009-17 Ram 1500 Short, Standard & Long Box  
Installation Instructions

### Storing the Hitch Ball



1. Rotate the locking collar to release the latch pawl. Align the ball with the collar and drop the ball into the hitch.

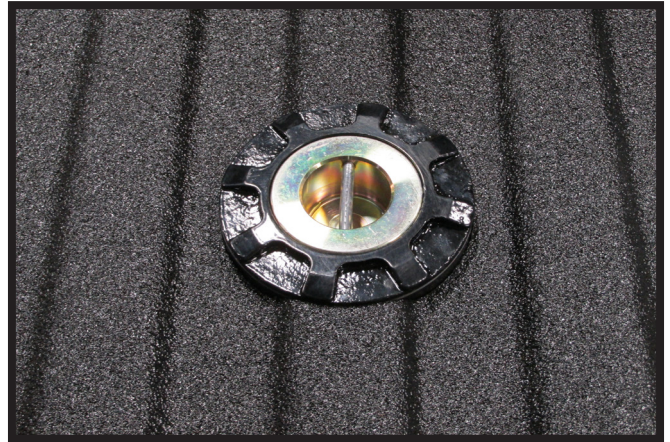

2. Release the locking collar.

### CUSTOMER SERVICE COMMITMENT

Blue Ox® is committed to providing you with exceptional customer care throughout your lifetime with our products. Our team is here to assist you with any questions you may have regarding the performance of your product. Simply call (402) 385-3051 and you can speak with our technical service team.

Additionally, please visit our website to see which rallies our Destination America team will be attending. For a nominal fee, our service technician will service your towing system to ensure it's in proper working condition. Also, as a commitment to our customers, should you visit our factory, you can stay at our full service Blue Ox® campground at no charge along with enjoying a factory tour.

Again, thank you for being our customer and for the confidence you have shown in the performance of our products. It is because of customers like you we enjoy the success we have today.

© 2016 Blue Ox  
One Mill Road, Industrial Park  
Pender, Nebraska 68047  
Phone: (402) 385-3051  
Fax: (402) 385-3360  
[www.blueox.com](http://www.blueox.com)



# BLUE OX ORIGINAL PURCHASERS LIMITED LIFETIME WARRANTY

Automatic Equipment Manufacturing Company ("Automatic") warrants to the original (first) retail purchaser that this product, manufactured by Automatic, shall be free from defect in material and workmanship under normal use and service for as long as the original retail purchaser owns the product.

During said period, Automatic will repair or replace any parts that have been returned by the original purchaser, to the factory, transportation prepaid, and in Automatic's sole and absolute opinion found to be defective.

Limitations on Warranty Coverage:

Coverage under this warranty will be valid only if the customer warranty card is returned by the original purchaser within 30 days of purchase.

Coverage under this warranty will be effective only when a copy of the original invoice, showing date and place of purchase, accompanies any claim for warranty. This warranty is NON TRANSFERABLE.

This limited warranty will not cover, in any way or form, any alleged damages caused by incorrect or improper installation, improper use, modification or neglect of product, failure to properly service and maintain, misuse, act of God, accident or failure of the user to follow guidelines contained in the instructional material provided by Automatic.

This warranty does not cover normal wear and tear, paint or rust.

Warrantor assumes no responsibility to the owner for loss of use of product, loss of time, inconvenience or any other damage consequential or otherwise. Including, but not limited to mileage, expense of transporting of product, return shipping expense, mechanics travel time, telephone, road service, towing, and rental during repairs, travel, lodging, loss or damage to personal property or loss of earnings.

**REPAIR OR REPLACEMENT AS SET FORTH IN THIS LIMITED WARRANTY IS THE SOLE EXCLUSIVE REMEDY OF THE PURCHASER. AUTOMATIC SHALL NOT BE LIABLE FOR ANY INCIDENTAL OR CONSEQUENTIAL DAMAGES FOR BREACH OF ANY EXPRESS OR IMPLIED WARRANTY ON THIS PRODUCT. EXCEPT TO THE EXTENT PROHIBITED BY APPLICABLE LAW, ANY IMPLIED WARRANTY OF MERCHANTABILITY OR FITNESS FOR A PARTICULAR PURPOSE ON THIS PRODUCT IS LIMITED IN LENGTH TO THE DURATION OF THIS WARRANTY.**

Please visit <http://blueox.com/warranty/> to register your warranty

